



Product name

Counterstay

For use with series 21 and series 21-E. Series 22-1-AS only for 22-1 and 22-2.

Art. No. 22-2

Series 22

EAN 4021176012303

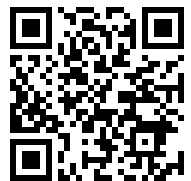

	Technical attribute	Metric	Imperial
	Spread counter support	100 mm	
	Counterstay reach	165 mm	
	Support surface	14 x 18 mm	
max.	Maximum load	4 t	4 US t
	Weight	1.873 kg	



has to be accomplished with

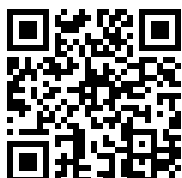

Internal extractor

21-3

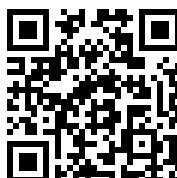

Internal extractor

21-4

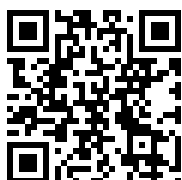

Internal extractor

21-5

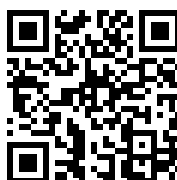

Internal extractor

21-6

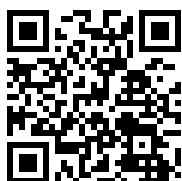

Internal extractor

21-7

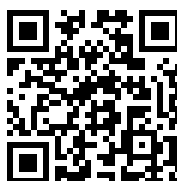

Internal extractor

21-8

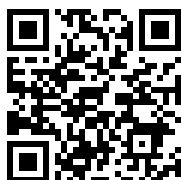

Internal extractor with segmented grasp edge

21-0-E



Internal extractor with segmented grasp edge

21-00-E

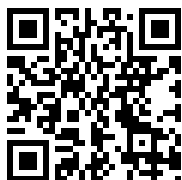

Internal extractor with segmented grasp edge

21-01-E

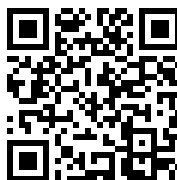

Internal extractor with segmented grasp edge

21-1-E

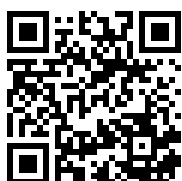

Internal extractor with segmented grasp edge

21-2-E



Internal extractor with segmented grasp edge

21-3-E



has to be accomplished with



Internal extractor with segmented grasp edge

21-4-E

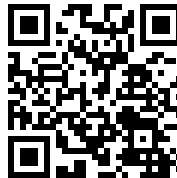

Internal extractor with segmented grasp edge

21-5-E

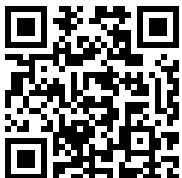

Internal extractor with segmented grasp edge

21-6-E

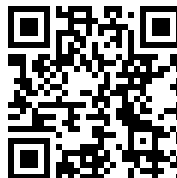

Internal extractor with segmented grasp edge

21-7-E



Needle bearing extractor

21-40

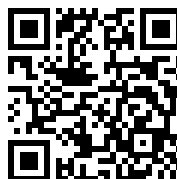

Needle bearing extractor

21-41



Needle bearing extractor

21-42

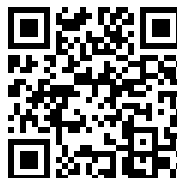

Needle bearing extractor

21-43

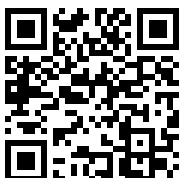

Needle bearing extractor

21-44



Needle bearing extractor

21-45

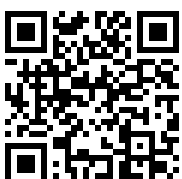

Needle bearing extractor

21-46



Technologies



LIGHT SHIFT

Free-moving, self-retaining jaws with internal spring washer.



EASY SCREW

The built-in thrust bearing facilitates rotation through reduced frictional resistance.



Spare part

Art. No.	Product name
22-2-T	Cross-beam
022-206	Spindle
22-2-1-P	Pair of spare hooks with fixing material

Accessories

Art. No.	Product name
22-1-AS	Set of thread inserts

Goes with

Art. No.	Product name
225-SK	Extractor with self-centering jaws
21-3	Internal extractor
21-4	Internal extractor
21-5	Internal extractor
21-6	Internal extractor
21-7	Internal extractor
21-8	Internal extractor
21-0-E	Internal extractor with segmented grasp edge
21-00-E	Internal extractor with segmented grasp edge



Goes with

Art. No.	Product name
21-01-E	Internal extractor with segmented grasp edge
21-1-E	Internal extractor with segmented grasp edge
21-2-E	Internal extractor with segmented grasp edge
21-3-E	Internal extractor with segmented grasp edge
21-4-E	Internal extractor with segmented grasp edge
21-5-E	Internal extractor with segmented grasp edge
21-6-E	Internal extractor with segmented grasp edge
21-7-E	Internal extractor with segmented grasp edge
21-40	Needle bearing extractor
21-41	Needle bearing extractor
21-42	Needle bearing extractor
21-43	Needle bearing extractor
21-44	Needle bearing extractor
21-45	Needle bearing extractor
21-46	Needle bearing extractor
22-1-AS	Set of thread inserts
225-1	Extractor with self-centering jaws
225-2	Extractor with self-centering jaws
225-3	Extractor with self-centering jaws
21-44-E	Needle bearing extractors



Part of

Art. No.	Product name
24-A	Set of bearing pulling and extracting tools
24-B	Set of bearing pulling and extracting tools
24-C	Set of bearing pulling and extracting tools
25-A	Set of bearing extracting tools
25-B	Set of bearing extracting tools
25-C	Set of bearing extracting tools
28-C	Set of slide hammer and counterstays for extracting ball bearings and dowel-pins
28-D	Set of slide hammer and counterstays for extracting ball bearings and dowel-pins
WT-017	Puller product range - interior pulling - BASIC
WT-018	Puller product range - interior pulling - TOP
K-22-B	Ball bearing extracting set with counterstay and slide hammer
EVLW-2-INDUSTRIE	Display
EVLW-2-KFZ	Merchandiser, automotiv pullers
EVLW-2-NFZ	Merchandiser, automotive pullers / commercial vehicle / agricultural machinery



Spare part of

Art. No.	Product name
24-A	Set of bearing pulling and extracting tools
24-B	Set of bearing pulling and extracting tools
24-C	Set of bearing pulling and extracting tools
25-A	Set of bearing extracting tools
25-B	Set of bearing extracting tools
25-C	Set of bearing extracting tools

Also included in

Art. No.	Product name
WT-018	Puller product range - interior pulling - TOP

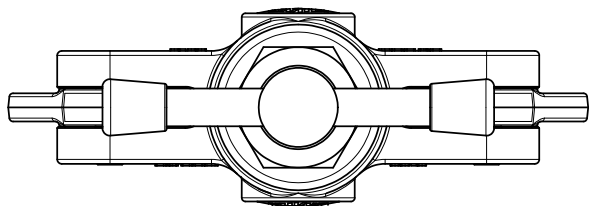
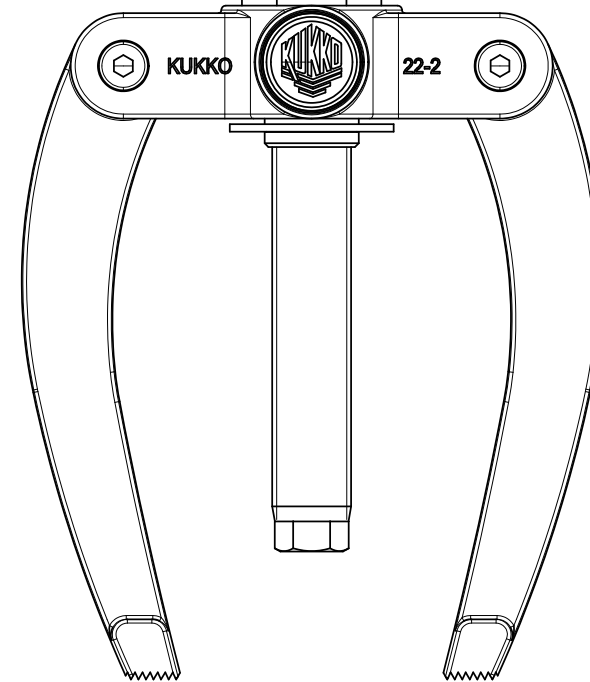
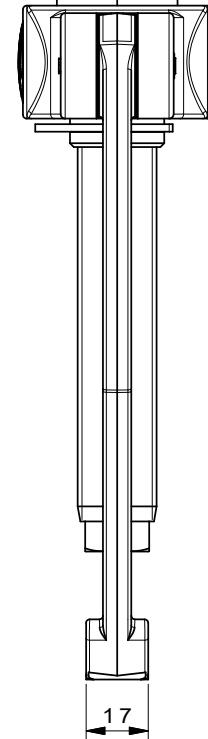
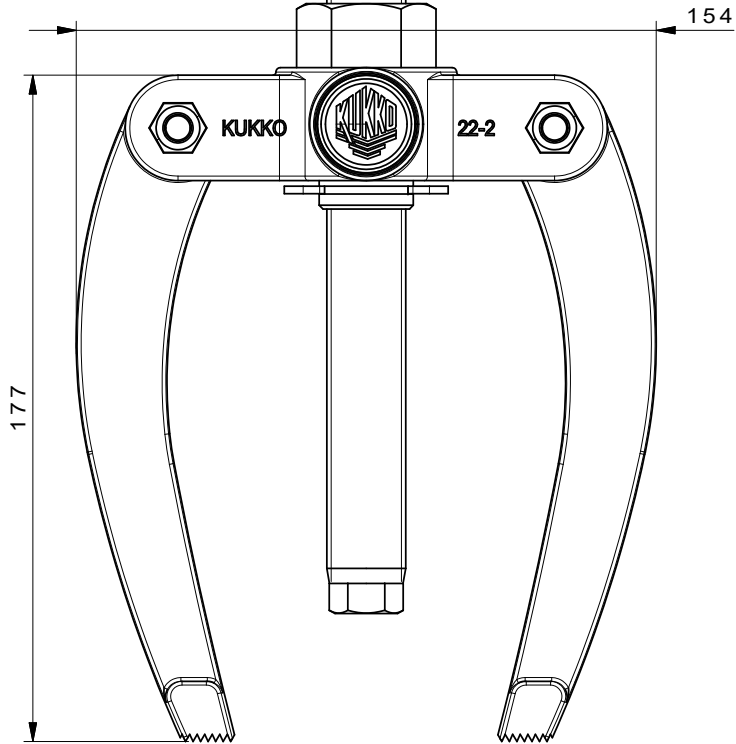
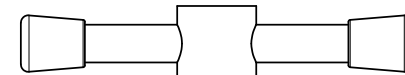
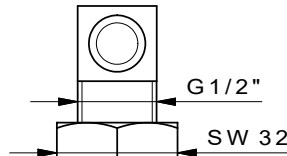
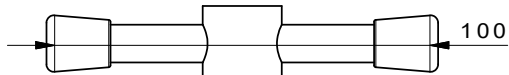
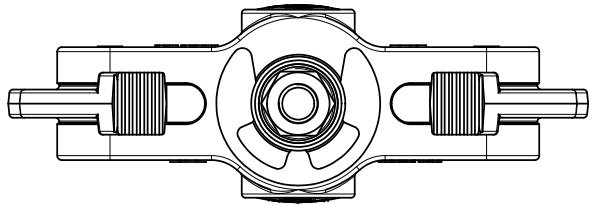

 Kleinbongartz & Kaiser oHG Werkzeugfabrik Hilden - Germany	Dokumentname: 22-2_Gegenstütze	Toleranz: DIN ISO 2768-m
	Dokumentbeschreibung: Baugruppe	Material: Hoch legierter Werkzeugstahl / High alloy tool steel
Erstellt / Geprüft von: Schultes	Erstellungsdatum: 30/03/2015	Maßstab: 1:1
Teilbeschreibung: Gegenstütze/ Counterstay		Wärmebehandlung / Härte: vergüteter Stahl/ tempered steel
		Oberflächenbehandlung:
Artikelnummer / ZNR.: 22-2	Dokumentversion: -	Schutzvermerk ISO 16016 beachten